

EBX15-BS (12V13Ah)

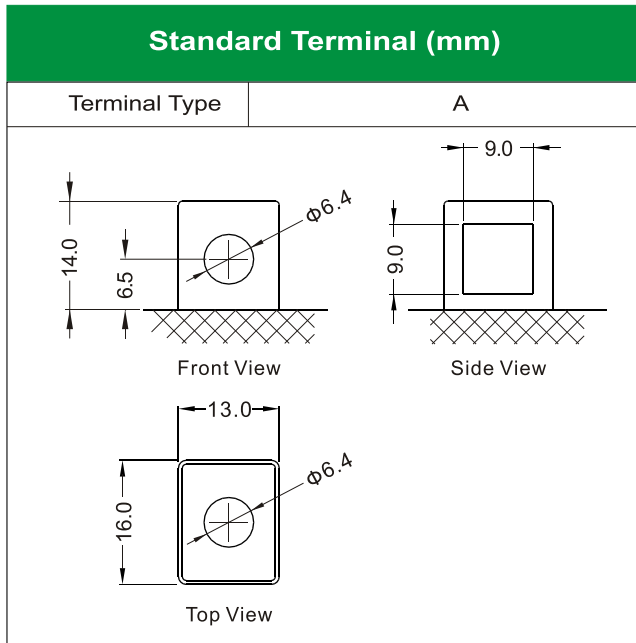
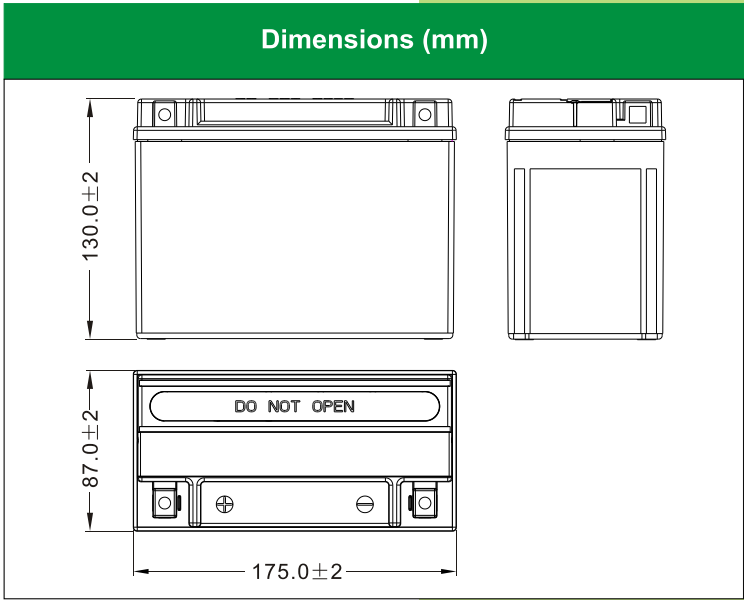

Physical Specification

Nominal Voltage	12V	
Nominal Capacity (10HR)	13AH	
Dimension	Length	175±2mm (6.89 inches)
	Width	87±2mm (3.43 inches)
	Container Height	130±2mm (5.12 inches)
	Total Height (with Terminal)	130±2mm (5.12 inches)
Weight	Battery(with acid): Approx 4.71kg (10.37lbs)	
	Electrolyte: Approx 0.90kg (1.98lbs)	

- * Sealed and non-spillable AGM battery
- * Maintenance-free
- * Powerful 230 cold cranking amps
- * Shipped pre-charged and ready to install
- * Replaces / upgrade for EB15-4

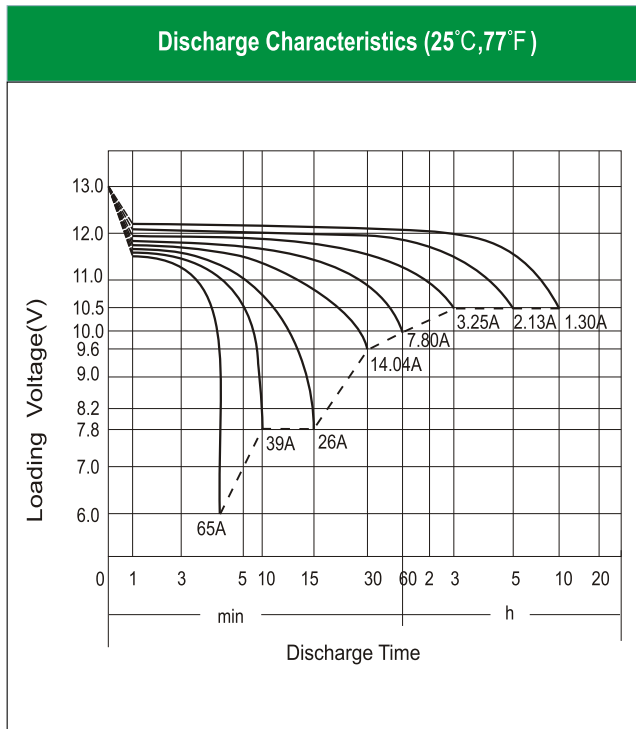

Electrical Specification

Rated Capacity	10 hour rate (1.30 A)	13.0AH
	5 hour rate (2.13 A)	10.66AH
	2 hour rate (4.55 A)	9.10AH
	1 hour rate (7.80 A)	7.80AH
	0.5 hour rate (14.04 A)	7.02AH
Capacity affected by Temperature	40 °C (104 °F)	106%
	25 °C (77 °F)	100%
	0 °C (32 °F)	86%
	-15 °C (5 °F)	65%
Self Discharge	Approximately 3% per month (25°C (77°F))	
Charging Methods	Full Charge	Constant-Voltage Charge: Initial charging current: less than 3.9A Voltage: 14.40 V ~ 15.00 V at 25 °C (77 °F) Charging time: 15 ~18h Constant-Current Charge: Charging current: 0.1C ₁₀ =1.30A, when charging voltage up to 14.40V, continue to charge 4h
	Floating Charge	No limit on Initial charging current Voltage: 13.50 V ~ 13.80 V at 25 °C (77 °F)